

Yike C02 series 35W 8000 lumen 9006 Car LED headlight conversion kits

Feature:

1. Original CREE's LED chip, 8000 lumen per pair.
2. Aviation Aluminum Alloy Appearance, stable and outstanding performance.
3. Perfect light shape.
4. Imported original double ball bearing cooling fan, 10000 revolution per minute, high Thermal Conductivity Patent.
5. Import Aerospace Materials with special design cooling.
Pure Aluminum cold forging radiator is 10% faster than ordinary aluminum alloy.
6. In accordance with the international, standard design special- purpose plug, perfect matching the original car plug.
7. Power box shell design, anti-interference, small size, easy to place the vehicle installation.
8. Plug and Play, small in size, good installation, fit more cars.
9. Instant start.

Packaging Details:

2pcs/color gift box; 40sets/carton

Color box size: 200*53*175mm

Packaging size: 560*415*375mm

Warranty:

18 months



C02 SERIES

Professional automotive
LED headlights



C02-9006

[PRODUCT MANUAL](#) →

Series type

H7 | H11 | 9005 | 9006 | 9012 | D2S

SPECIFICATION

Led Chip: CREE XHP50

Beam Angle: 280°

Max Light Output: 5000 lumen/pcs

Temperature: -40 ° C ~ + 85 ° C

Start output: 4000 lumen/pcs

Luminous Efficiency: >80%

Start Output: 4000 lumen/pcs

Luminous Efficacy: 280%

Light color : 5000K/6500K

Startup: Instant start

Power: 35W

Installation: Plug and Play

Voltage: DC12V

Life Span: 30000hours

Input(A): 2.9±0.1A

Waterproof: IP65

C02 SERIES LED HEADLAMP SIZE

Small size with replaceable base, high rate of installation and fast replacement from one model to another model.

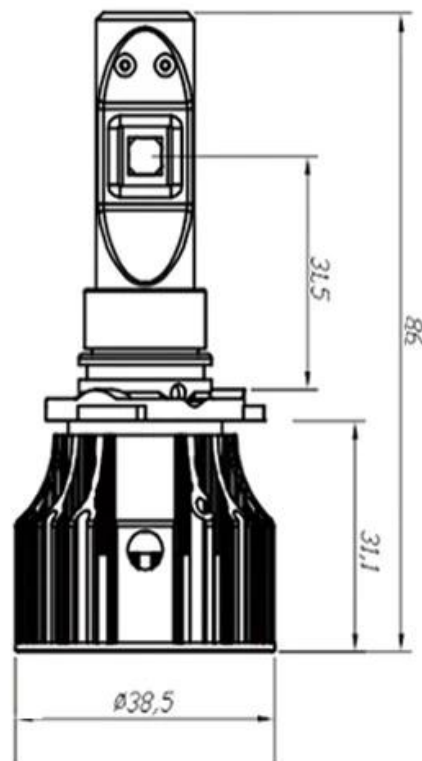

Light angle $\geq 140^\circ$



Two sides of the light emitting design
Wide range of light and field of vision.
Safe driving at night.

- ▶ High power LED chip, proofread carefully, the lighting is same as the original halogen perfectly.

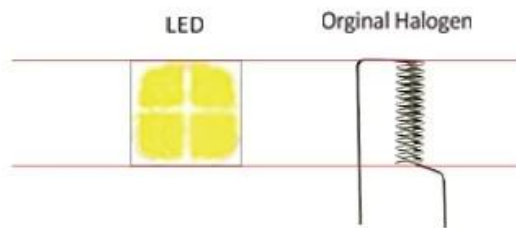

- ▶ **The light is on the ground uniformly**
Design in full accordance with the halogen light center to achieve the perfect light shape.

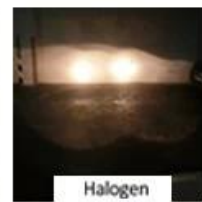

CREE-XLamp XHP50 LEDs



SUPER BRIGHTNESS CHIPS

Original America Cree LED chips,
ultrabrightness, strong light-focusing
Lifetime can be 60000-100000 hours

Plane high-effect and high-power CREE chip, wide
range of light angle ($\geq 140^\circ$), high lumens.



Wide range of light
and field of vision

High lumen
8000lm per pair

Spot light
perfect shape

High speed double-ball bearing
30000 revolution per minute



High power CREE's LED chip,
8000lumen per pair.



Aviation Aluminium Alloy Appearance
Stable and outstanding performance



Perfect matched adaptor



Import Aerospace Materials with
special design, cooling.
Pure Aluminium cold forging
radiator is 10% faster than
ordinary aluminium alloy



Imported original double ball
bearing cooling fan.
High Thermal Conductivity
Patent.





In accordance with the international, standard design special-purpose plug, perfect matching the original car plug



Power box shell design, anti-interference, small size, easy to place the vehicle installation

PRODUCT DETAILS

Perfect Quality

Flux Right & Left
8000



**8000
LUMEN**

9006



Flux Right & Left

**8000
LUMEN**

9006



Flux Right & Left

**8000
LUMEN**



9006

Flux Right & Left

8000
LUMEN

9006

OUR ADVANTAGES

Product Value

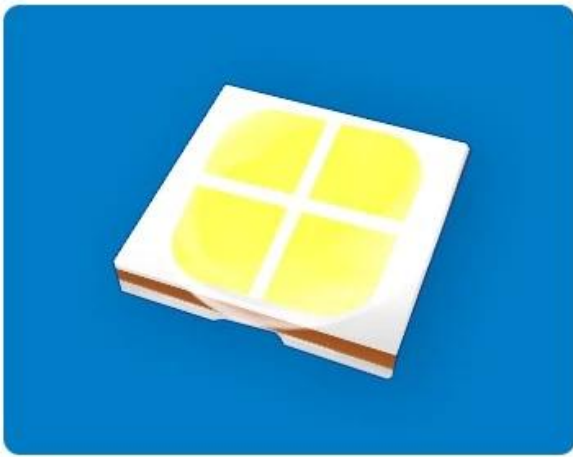

Super Brightness

High power CREE's LED chip, 8000 lumen per pair.

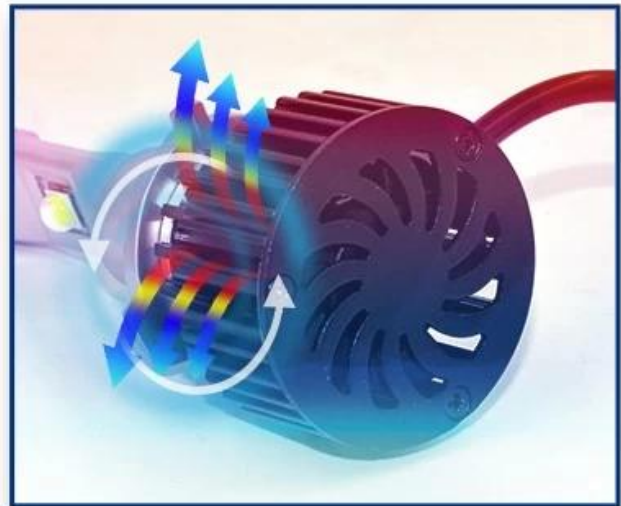

Intelligent Heat Radiator

Intelligent heat-dissipation system.
Safe guard of the led bulb .

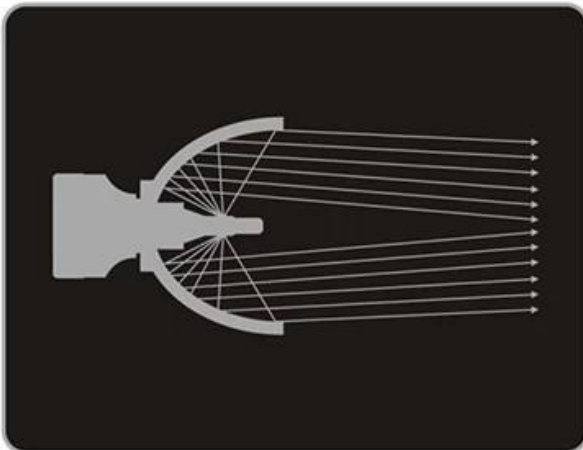

Perfect light shape

Same LCL as the original car light.

EMC function

Electro Magnetic Compatibility design according to GB-18655 standards



Instant start

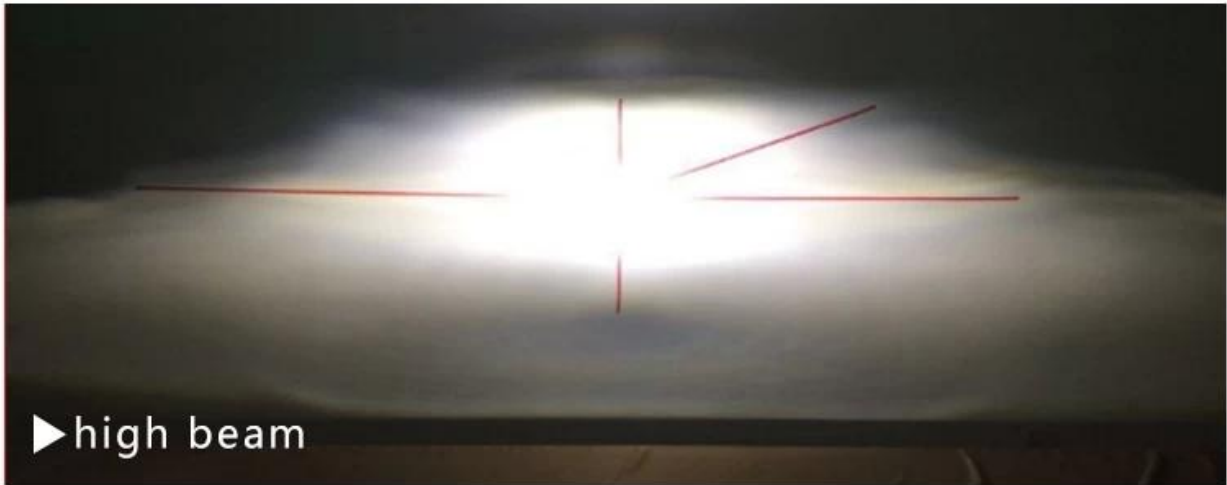

AVAILABLE MODELS FOR YOUR OPTION

C02



C02-9005



C02-9006



C02-9012



C02-H1



C02-H4



C02-H7



C02-H11



C02-H15



C02-D1S



C02-D2S

更多型号
敬请期待.....

AUTO LED HEADLIGHT

PRODUCTION LINE & OUR SHOWS

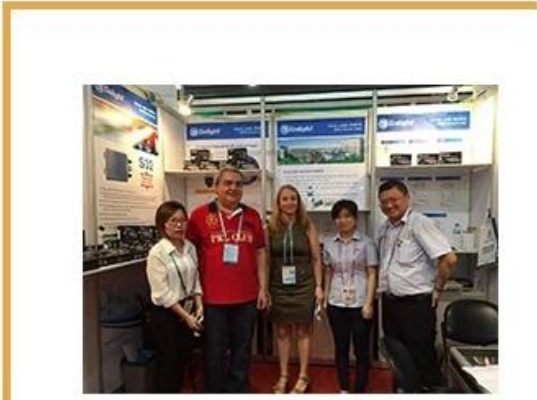

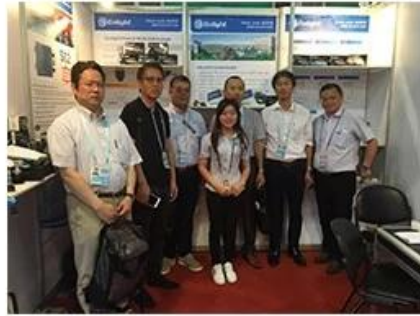
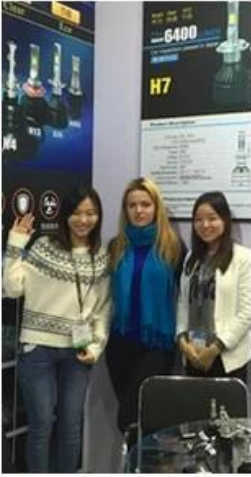

LED PACKING

OEM & ODM

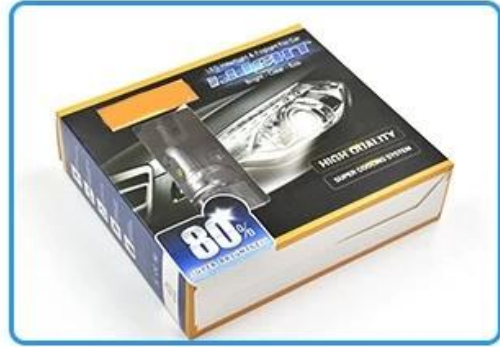



OUR SERVICES

1. Sample order is welcome, we charge the sample for the first time but sample cost can be reduced in formal order.
2. OEM & ODM are available.
3. Customized package available.
4. Usually 18 months warranty.

OUR COMPANY

We are top quality LED car headlight manufacturer, with over 25 years history and over 2,000 employees.

Warmly welcome to visit us.



